

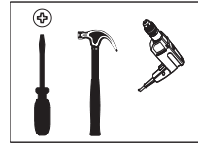

BX02







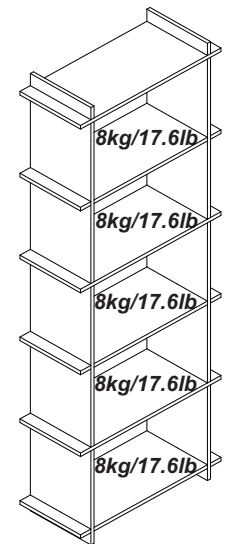
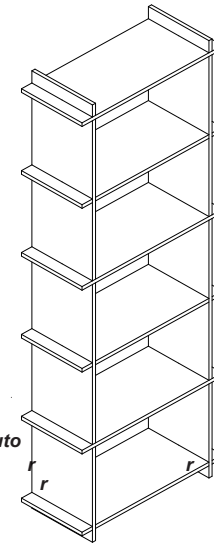

Ferramentas necessárias
(não fornecidas)
Необходимые
инструменты(не входят в
комплектацию)

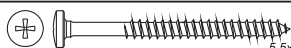

Peso Máximo
suportado pelo produto



- ooo
- xs lr r r s
 - ps r r lr lr r r
 - as r r r r lr r r r
 - 8s r r r lr r r r r r
 - ks r r s r r r r
 - /s r lr r r r lr r r lr
 - 1s lr r r r r s r r r lr
 - 7s r r r r r r r r lr
1. Á Á Á Á Á Á Á
 2. Á Á Á Á Á Á Á Á

ФУРНИТУРА	(mm)	КОЛ-ВО	Ferragens/Herrajes/Ironmongery	(mm)	QTD.
A		04	E		04
B		04	F		04
C		12			
D		04			

КОД	ОПИСАНИЕ	КОЛ-ВО	РАЗМЕРЫ	mm	in
1-x5004	Боковая панель	02	1800x294x15	70.9x11.6x0.59	
2-x5005	Полка	06	675x294x15	26.6x11.6x0.59	

**МОНТАЖ
MONTAJE
ASSEMBLING**

2°

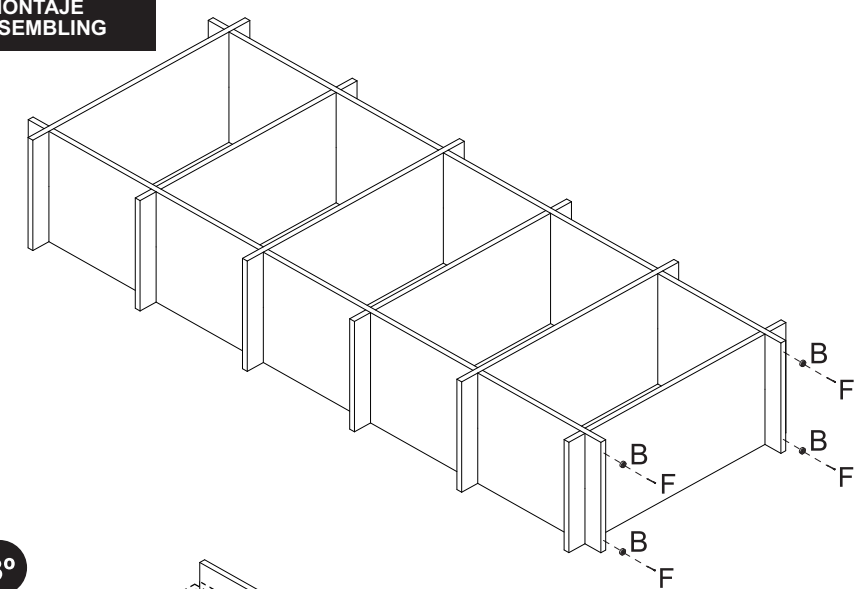

1°

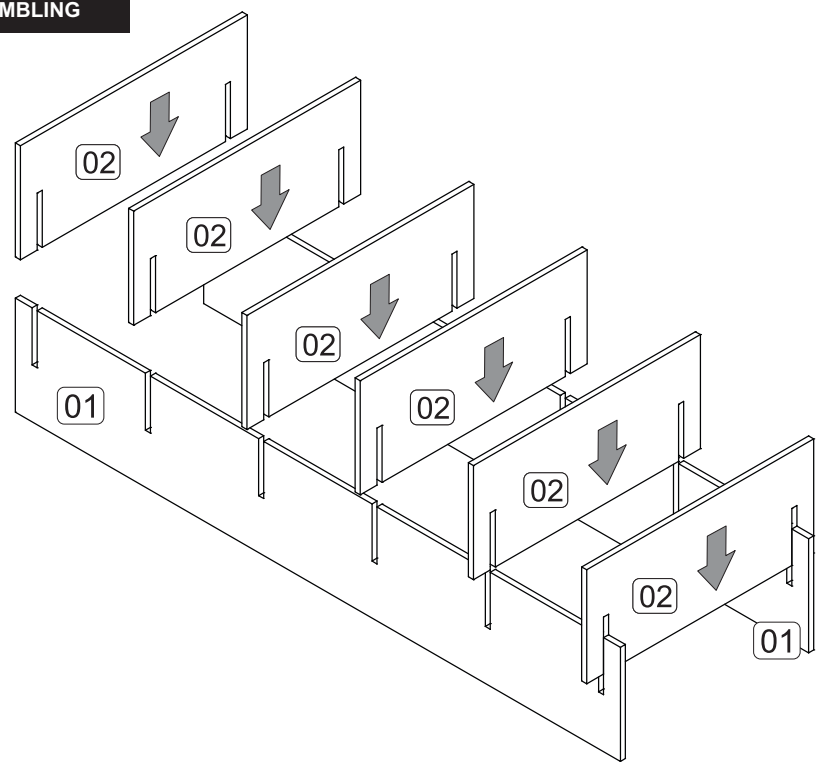

3°

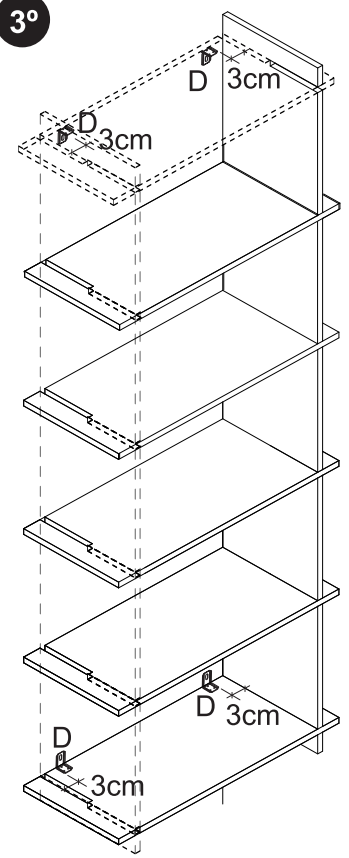

Fixação na parede
Fijación en la pared
Фиксация на стене

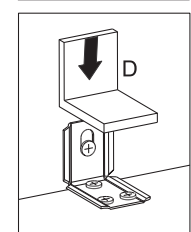
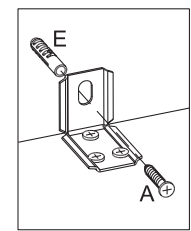
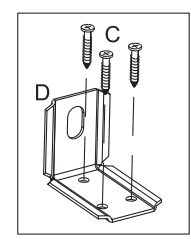

Fixação da bucha
Fijación casaquillo
Фиксация заглушки

